

K[®] GNB GROUP

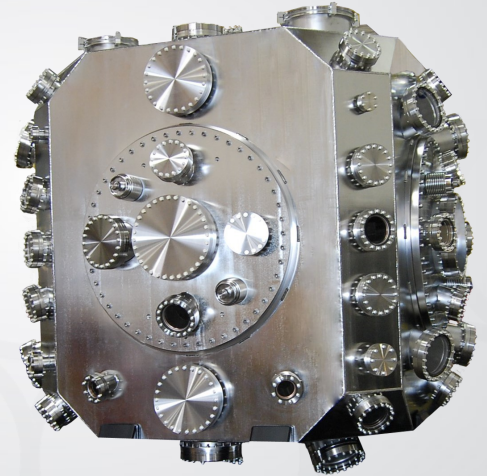

VACUUM PRODUCTS CATALOG

INTRODUCTION



Chris Long
President/CFO

Thomas Dobler
CEO

Mark Putz
Production Mgr.















GNB KL Group is a company of technical experts serving other technology experts. Since our beginning in 1968, it has been our commitment to technology that has set us apart. During this time we have produced outstanding, innovative products that have met the most demanding applications in areas such as temperature extremes, large sizes, radiation levels, vacuum levels, vibration levels, and other unique applications.

GNB KL Group is about more than just technology, we are passionate about building winning relationships. It is our corporate vision that customers will be so impressed that they say, "Wow! We want to do business with GNB again."

We have deigned this catalog as an overview of all product lines offered at GNB KL Group. Please contact us directly for your specific company needs.

TABLE OF CONTENTS

Valves

	Angle Valves Small.....	05
	Angle Valves Large	06
	Ball Valves.....	07
	Kompact Gate Valves.....	08
	Aluminum Gate Valves.....	09
	Smart Gate Valves.....	10
	Space Saver Gate Valves.....	11
	Direct Linear Gate Valves	12
	Semiconductor Slit Valves.....	13
	Slit Valves.....	14
	Specialty & Metallurgical Valves.....	15
	Accessories & Cryo Products.....	17-20
	NanoPure Products.....	21
	Standard Components.....	23-24
	GNB Chambers.....	26-31

Valves

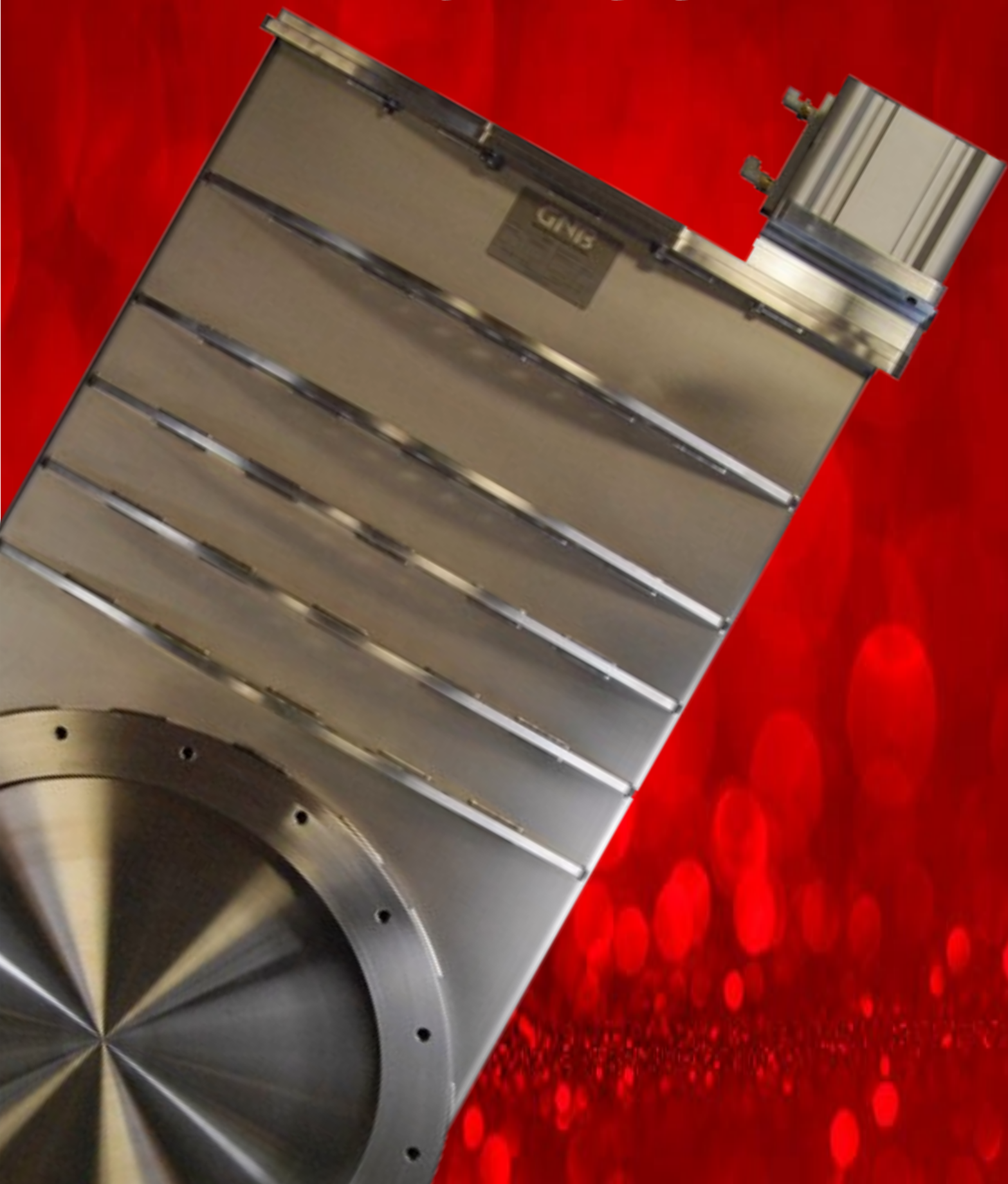

ANGLE VALVES SMALL



Right Angle



In-Line



Z-Type In-Line

MAIN APPLICATIONS

- Pumping and Venting of HV and UHV systems

AVAILABLE VERSIONS

- Flange Types:
 - ISO-K (KF16-KF50)
 - ISO-F (63-250)
 - CF (OD1.33"-8" / ID 3/4"-6" (16-160mm))
 - Tube Ends for Weld Connections
- Bonnet Seal
 - FKM
 - OFHC Metal Gasket (UHV Version)
- Actuator:
 - Manual / Hand Wheel
 - Pneumatic (Position Indicators and Solenoid optional)
 - Spring Closed up to KF50

PRODUCT SPECIFICATION

- Pressure Range:
 - 10^{-8} mbar to 2bar (abs) (FKM)
 - 5×10^{-10} mbar to 2bar (abs) (UHV Version)
- Leak Rate:
 - Valve Body:
 - HV Version $< 1 \times 10^{-9}$ mbar Is^{-1}
 - UHV Version $< 1 \times 10^{-10}$ mbar Is^{-1}
 - Valve Seat: $< 1 \times 10^{-9}$ mbar Is^{-1}
- Cycle Life:
 - $> 1,000,000$
- Max Temperature:
 - 200C / 392F
- Material
 - Body: 304L
 - Actuator: 6061 Aluminum
 - Feedthrough: Bellows AM350

ANGLE VALVES LARGE



MAIN APPLICATIONS

- Diffusion Pump Isolation.
Can be combined with GNB Baffles to reduce Backstreaming

AVAILABLE VERSIONS

- Flange Types:
 - ISO-K or ISO-F 320 to 1000
 - ASA 12" to 40" ID
 - Custom Flanges
- Bonnet Seal
 - FKM (Stainless Versions)
 - Buna (Mild Steel Versions)
- Actuator:
 - Pneumatic (Position Indicators and Solenoid Included)
 - Hydraulic
- Feedthrough:
 - Dual O-Ring Shaft Feedthrough
 - Hydroformed Bellows Feedthrough
 - Welded AM350 Bellows
- Common Options:
 - Ports on Body, Water cooling, and more

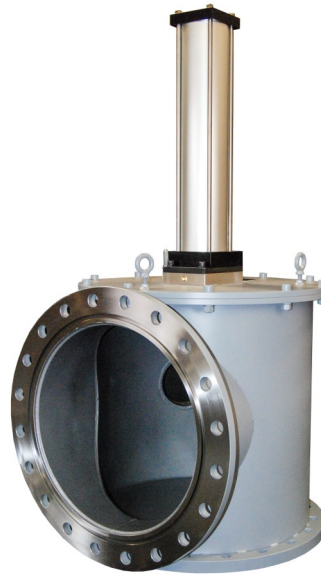

PRODUCT SPECIFICATION

- Pressure Range:
 - 10^{-6} mbar to 1.2bar(abs)Mild Steel
 - 10^{-8} mbar to 1.2bar(abs)Stainless
 - 10^{-9} mbar to 1.2bar(abs)w Bellows
- Leak Rate:
 - Valve Body: $< 1 \times 10^{-9}$ mbar Is^{-1}
 - Valve Seat: $< 1 \times 10^{-9}$ mbar Is^{-1}
- Cycle Life:
 - > 100,000 with Shaft Feedthrough
 - > 1,000,000 with Bellows
- Max Temperature:
200C / 392F
- Material
 - Stainless Steel 304 or 316
 - Painted Mild Steel A36

BALL VALVES



MAIN APPLICATIONS

- General Purpose Valves
Ball Valves work in very harsh vacuum applications and are often used in exhaust lines of Semiconductor tools

AVAILABLE VERSIONS

- Flange Types:
 - ISO-K (KF16-KF50)
 - Tube Ends 3/4" - 2"
- Feedthrough:
 - FKM
- Gate Seal:
 - PTFE
- Actuator:
 - Manual / Hand Lever
 - Pneumatic
Solenoid optional
 - Visual Position Indicator Included



PRODUCT SPECIFICATION

- Pressure Range:
 - 10^{-5} mbar to 6bar (abs)
- Leak Rate:
 - Valve Body: $< 1 \times 10^{-8}$ mbar ls⁻¹
- Cycle Life:
 - > 30,000
- Max Temperature:
 - 200C / 392F
- Material:
 - Body and Ball 316L Stainless
 - Pneumatic Actuator: Aluminum
 - Manual Actuator: 304L w. cover

KOMPACT GATE VALVES



Manual



Pneumatic

MAIN APPLICATIONS

- General Purpose small UHV gate valve

AVAILABLE VERSIONS

- Flange Types:
 - CF2.75" (40mm ID)
- Bonnet Seal
 - OFHC Metal Gasket
- Gate Seal
 - Vulcanized FKM Seal
- Actuator:
 - Manual / Hand Wheel
 - Pneumatic (Position Indicators and Solenoid Included)
 - SMART Lock System to keep valve closed without compressed air pressure

PRODUCT SPECIFICATION

- Pressure Range:
 - 1×10^{-10} mbar to 2bar (abs)
- Leak Rate:
 - Valve Body: $< 5 \times 10^{-10}$ mbar ls⁻¹
 - Valve Seat: $< 1 \times 10^{-9}$ mbar ls⁻¹
- Cycle Life:
 - >100,000
- Max Temperature:
 - 200C / 392F
- Material
 - Body: 304L
 - Gate: 304L
 - Feedthrough: Bellows AM350

ALUMINUM GATE VALVES



MAIN APPLICATIONS

- General Purpose low cost aluminum Gate Valve

AVAILABLE VERSIONS

- Flange Types:
 - ISO-F 100 to 250
- Bonnet Seal
 - FKM O-Ring
- Gate Seal
 - FKM O-Ring
- Feedthrough
 - Dual FKM O-Ring
- Actuator:
 - Pneumatic (Position Indicators and Solenoid included)
 - Roller Lock System to keep valve

PRODUCT SPECIFICATION

- Pressure Range:
 - 1×10^{-7} mbar to 1.6bar (abs)
 - 1×10^{-7} mbar to 1.2bar(abs) DN250
- Leak Rate:
 - Valve Body: $< 1 \times 10^{-9}$ mbar ls^{-1}
 - Valve Seat: $< 1 \times 10^{-9}$ mbar ls^{-1}
- Cycle Life:
 - DN100: $> 200,000$
 - DN160 to DN250 $> 100,000$
- Max Temperature:
 - 120C / 248F
- Material
 - Body: 6061 Aluminum
 - Mechanism: 6061 Aluminum

SMART GATE VALVES



MAIN APPLICATIONS

- General Purpose HV and UHV Stainless Gate Valves

AVAILABLE VERSIONS

- Flange Types:
 - ISO-F (63 - 200)
 - CF OD 4.5"-10" / ID 2.5"-8" (63-200mm)
 - ASA and other Flange Types on Request
- Bonnet Seal
 - FKM (SMART Valve and HV In-Axis)
 - OFHC Metal Gasket (UHV In-Axis)
- Feedthrough
 - SMART: Rotary Type FKM
 - In-Axis HV: Welded Bellows AM350
 - in Axis UHV: Welded Bellows AM350
- Actuator:
 - Manual / Hand Lever
 - Pneumatic (Position Indicators and Solenoid Included)

PRODUCT SPECIFICATION

- Pressure Range:
 - 10^{-8} mbar - 1.2bar (abs) SMART
 - 10^{-8} mbar - 1.2bar(abs) In-Axis HV
 - 10^{-10} mbar - 1.2bar(abs) UHV
- Leak Rate:
 - Valve Body:

SMART	< 1×10^{-9} mbar ls ⁻¹
In-Axis HV	< 1×10^{-9} mbar ls ⁻¹
In-Axis UHV	< 1×10^{-10} mbar ls ⁻¹
UHV Version	< 1×10^{-10} mbar ls ⁻¹
 - Valve Seat: < 1×10^{-9} mbar ls⁻¹
- Cycle Life:

SMART	>200,000
In-Axis HV	>200,000
In-Axis UHV	>50,000
- Max Temperature: 200C / 392F
- Material
 - Body: 304L
 - Actuator: 6061 Aluminum

SPACE SAVER GATE VALVES



MAIN APPLICATIONS

- General Purpose HV and UHV Stainless Gate Valves. Ideal for Pump Isolation

AVAILABLE VERSIONS

- Flange Types:
 - ISO-F (250 to 500)
 - ASA 10" to 20" (ID)
 - Custom and other Flange Types
- Bonnet Seal
 - FKM Standard
 - OFHC Metal Gasket Optional
- Feedthrough
 - Welded Bellows AM350 rated for >1,000,000 cycles
- Actuator:
 - Pneumatic (Position Indicators and Solenoid Included)

PRODUCT SPECIFICATION

- Pressure Range:
 - 10^{-8} mbar - 1.2bar (abs)
- Leak Rate:
 - Valve Body: $< 1 \times 10^{-9}$ mbar ls^{-1}
 - with OFHC Seal $< 1 \times 10^{-10}$ mbar ls^{-1}
 - Valve Seat: $< 1 \times 10^{-9}$ mbar ls^{-1}
- Cycle Life: >200,000
- Max Temperature: 200C / 392F
- Material
 - Body: 304L
 - Actuator: 6061 Aluminum
 - Feedthrough: Bellows AM350

DIRECT LINEAR GATE VALVES



MAIN APPLICATIONS

- Large Cryo-Pump Isolation.
Standard Valve for Space Simulation
Valves worldwide

AVAILABLE VERSIONS

- Flange Types:
 - ISO-F 250 to 4000
 - ASA 10" to 160" ID
 - Custom Flanges
- Bonnet Seal
 - FKM (Stainless Versions)
 - Buna (Mild Steel Version)
- Actuator:
 - Pneumatic (Position Indicators and Solenoid Included)
 - Hydraulic
 - Electric
- Feedthrough:
 - Dual O-Ring Shaft Feedthrough
 - Welded AM350 Bellows
- Common Options:
 - Ports on Body, Water cooling (Gate, Body),
Lock our Tag Out (LOTO), and more

PRODUCT SPECIFICATION

- Pressure Range:
 - 10^{-6} mbar to 1.2bar(abs)Mild Steel
 - 10^{-8} mbar to 1.2bar(abs)Stainless
 - 10^{-9} mbar to 1.2bar(abs)w Bellows
- Leak Rate:
 - Valve Body: $< 1 \times 10^{-9}$ mbar Is^{-1}
 - Valve Seat: $< 1 \times 10^{-9}$ mbar Is^{-1}
- Cycle Life:
 - > 100,000 with Shaft Feedthrough
 - > 1,000,000 with Bellows
- Max Temperature:
200C / 392F
- Material
 - Stainless Steel 304 or 316
 - Painted Mild Steel A36

SEMICONDUCTOR SLIT VALVES



ARM Lock System

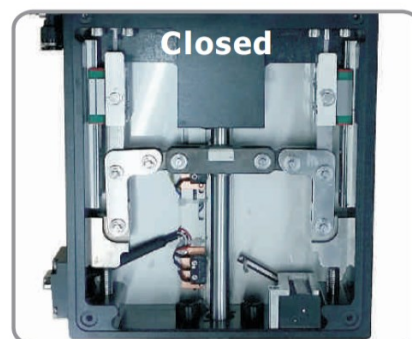
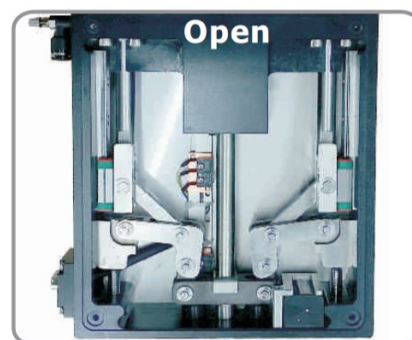

MAIN APPLICATIONS

- Transfer Valve for the Semiconductor Industry

AVAILABLE VERSIONS

- Available Sizes:
 - 32x222mm
 - 46x236mm
 - 50x336mm
 - 70x500mm
 - Other sizes on Request
- Bonnet Seal
 - FKM
 - OFHC Metal Gasket (UHV Version)
- Actuator:
 - Manual / Hand Wheel
 - Pneumatic with ARM Lock System (Position Indicators Included / Solenoid optional)

PRODUCT SPECIFICATION

- Pressure Range:
 - 10^{-8} mbar to 1bar (abs) (HV)
 - 10^{-10} mbar to 1bar (abs) (UHV)
- Leak Rate:
 - Valve Body:
 - HV Version $< 1 \times 10^{-9}$ mbar ls^{-1}
 - UHV Version $< 1 \times 10^{-10}$ mbar ls^{-1}
 - Valve Seat: $< 1 \times 10^{-9}$ mbar ls^{-1}
- Cycle Life: >5,000,000
- Max Temperature:
 - 200C / 392F (UHV)
 - 100C / 212F (HV)
- Material
 - Body: 304L or Aluminum
 - Actuator: 6061 Aluminum
 - Feedthrough: Bellows AM350

SLIT VALVES



MAIN APPLICATIONS

- For FPD, Glass Coaters and any other Applications that requires large Slit Valves

AVAILABLE VERSIONS

- Flange Types:
 - Any up to 4000x4000mm (160x160")
- Bonnet Seal
 - FKM (Stainless Versions)
 - Buna (Mild Steel Version)
 - Metal (Optional, UHV Version)
- Actuator:
 - Pneumatic (Position Indicators and Solenoid Included)
 - Hydraulic
 - Electric
- Feedthrough:
 - Dual O-Ring Shaft Feedthrough
 - Welded AM350 Bellows
- Common Options:
 - Ports on Body, Water cooling (Gate, Body), Lock out Tag Out

PRODUCT SPECIFICATION

- Pressure Range:
 - 10^{-6} mbar to 1.2bar(abs)Mild Steel
 - 10^{-8} mbar to 1.2bar(abs)Stainless
 - 10^{-9} mbar to 1.2bar(abs)w Bellows
 - 10^{-10} mbar to 1.2bar(abs)UHV
- Leak Rate:
 - Valve Body: $< 1 \times 10^{-9}$ mbar Is^{-1}
 - Valve Seat: $< 1 \times 10^{-9}$ mbar Is^{-1}
- Cycle Life:
 - > 100,000 with Shaft Feedthrough
 - > 1,000,000 with Bellows
- Max Temperature:
 - 200C / 392F
 - GNB valves can be designed for higher process temperatures with water cooling or metal seals
- Material
 - Aluminum
 - Stainless Steel 304 or 316
 - Painted Mild Steel A36

SPECIALTY AND METALLURGICAL VALVES

C-STYLE GATE VALVES



PENDULUM VALVES



SLIT VALVES



PMG GATE VALVES

PROTECTIVE METAL GUARDRING

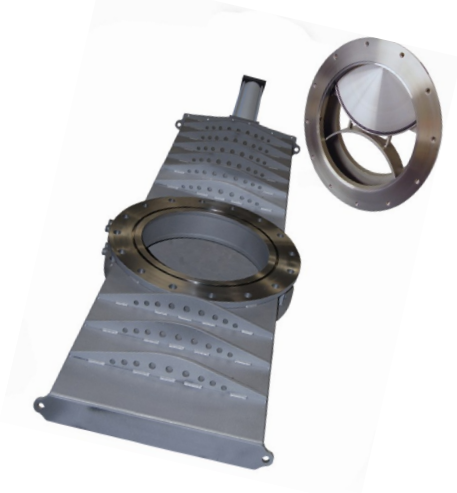

HIGH TEMPERATURE GATE VALVES



GATE VALVES



Accessories & Cryo Products

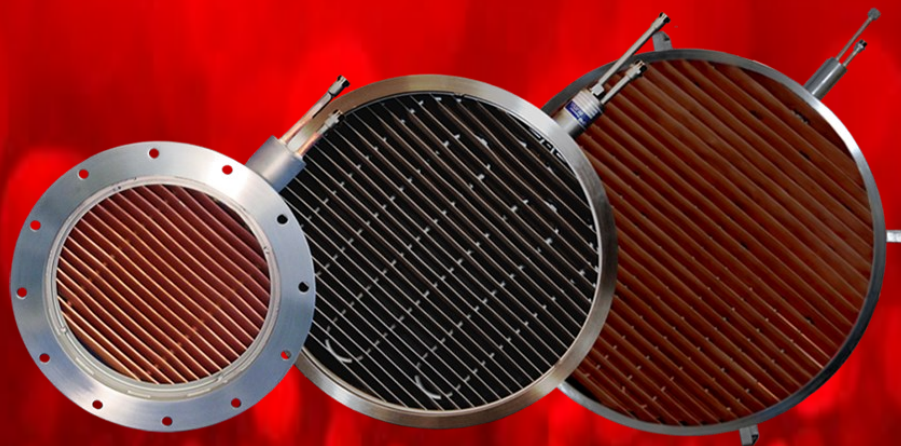

ACCESSORIES & CRYO PRODUCTS

Multicoolant Baffles



MCB



CMCB

- Sizes 2" (KF50) to 40" (ISO1000), Special sizes optional
- Leak Rate: $<1 \times 10^{-9}$ std cc/sec He
- Body Material: 304 SS
- Chevron Material: Copper (other options, like Aluminum and SS are available)
- Surface Finish: Bead Blasted
- Seals: FKM (Viton) (other options, like Silicone and Buna are available)

Liquid Nitrogen Trap



- Sizes 3.0" to 35.0" ID (Special sizes optional)
- Leak Rate: $<1 \times 10^{-9}$ std cc/sec He
- Body Material: 304 SS
- Chevron Material: Copper (other options, like SS, are available)
- Surface Finish: Bead Blasted
- Seals: FKM (Viton) (other options, like Silicone and Buna are available)

ACCESSORIES & CRYO PRODUCTS

Foreline Traps



- Sizes: KF16 through KF50 (3/4" through 2")
- Filter Material: Copper Wool
- Filter Type: Sealed
- Surface Finish: Bead Blasted
- Body Material: 304L SS

Cold Traps

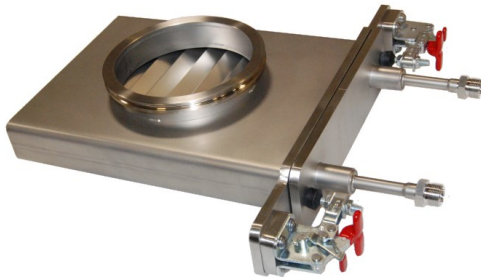

- Cold trap constructed of all stainless steel material
- Sizes 3.0" to 35.0" ID (Special sizes optional)
- Leak Rate: $<1 \times 10^{-9}$ std cc/sec He
- Body Material: 304 SS
- Chevron Material: 304 SS
- Surface Finish: Bead Blasted
- Seals: FKM (Viton) (other options, like Silicone and Buna are available)

Meissner Coils

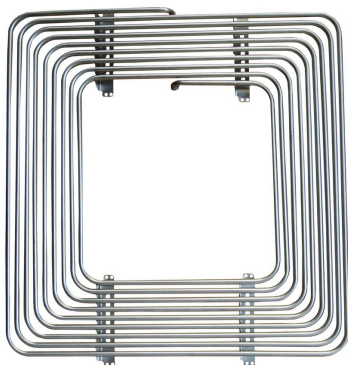

Cryo-coils or Meissner coils are the simplest cryo-product offered. They consist of coiled tubing meant to be placed in vacuum, that allows for a coolant to flow through the tubing. Water molecules or other particles then condense on the coil dropping the overall pressure of the chamber. This product is particularly useful in applications with high water content such as freeze-drying food products. Meissner coils are custom designed for each application.

ACCESSORIES & CRYO PRODUCTS

Quick Access Doors



Sizes: 4.5"CF, 6.0"CF, 8.0"CF, 10"CF

- Allows easy access into a chamber
- Available in Blank and Viewport types
- Door Seal: FKM
- Mounting Seal: OFHC Gasket
- Operating Pressure Range:
760Torr ~ 1×10^{-8} Torr
- Leak Rate: 1×10^{-9} Torr L/s He
- Temperature Range: -20degC ~ 150degC
- Bake Temperature: 100degC
- Body Material: 304LSS
- Viewport Material: Glass (only for viewport)

Viewports



Sizes:

- KF25, KF40, KF50
- 1.33"CF through 10.00"CF
- ISOK63 through ISOK250

- Glass Material: Kodial, Fused Silica, Sapphire
- Flange Style: CF, KF, ISOK
- Flange Material: 304SS
- Operating Pressure Range:
HV: 760 Torr ~ 1×10^{-8} Torr
UHV: 760 Torr ~ 1×10^{-10} Torr
- Leak Rate:
HV: $< 1 \times 10^{-9}$ std cc/sec He
UHV: $< 1 \times 10^{-10}$ std cc/sec He
- Temperature Range: -20degC ~ 350degC
(varies based on glass material)

Shutters



Sizes:

2.75"CF, 4.5"CF, 6.0"CF, 8.0"CF, 10"CF

- Protects a viewport from the deposition of materials in HV and UHV coating applications
- Double-Sided flange mount
- UHV grate rotary drive with thumbscrew for discrete angle positioning
- Bakeable to 250degC
- Shutter Material: Stainless Steel
- Mounting Seal: OFHC Gasket (both sides)
- Operating Pressure Range:
760Torr ~ 1×10^{-10} Torr
- Leak Rate: 1×10^{-9} Torr L/s He
- Temperature Range: -0degC ~ 200degC
- Bakeout Temperature: 250degC
- Body Material: 304LSS
- Feedthrough Type: UHV Rotary Drive
- Mounting Position: Any

ACCESSORIES & CRYO PRODUCTS

Bubblers



- Delivery and storage devices for chemicals
- DOT approved
- Volumes (standard): 100mL, 200mL, 500mL, 1L, 1.2L, 2.5L, 4L, 5L, 8L
- Leak Rate: $<1 \times 10^{-9}$ std cc/sec He
- Service Pressure: 300 psi
- Test Pressure: 600 psi
- Burst Volumetric Expansion Rate: $<10\%$
- Surface Finish, Interior and Exterior: Electropolished Ra 0.3 and below

Feedthroughs



- Baseplate Options: CF and KF
- Baseplate Materials: 304SS
- Conductor Material: 304SS, OFHC
- Voltage: 5000V
- Current: 7A (for 304SS), 180A (for OFHC)
- Insulation: Alumina Ceramic
- Vacuum Range: 760 Torr $\sim 1 \times 10^{-8}$ Torr
- Temperature Range: -100degC \sim 500degC

Heaters



- Molded heater jackets for vacuum products including check valves, poppet valves, chain clamps, pipe clamps, elbows, straight tube, manifolds, and more.
- Split design for easy installation
- Hybrid super thermal insulation

NANOPURE



NanoPure is a brand founded by the King Lai Group to provide a total solution for gas delivery applications. Consisting of various tubing/piping, fittings and valves, the NanoPure products are high quality hygienic materials manufactured for the semiconductor, FPD, LED and photovoltaic industries. Check out our website for the full product range and capabilities.

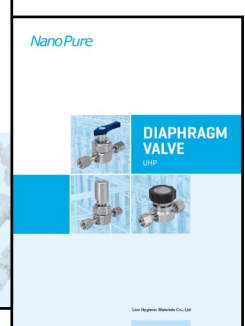
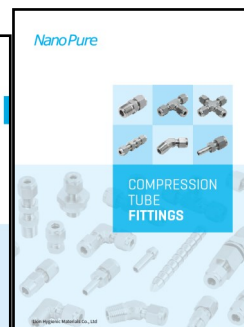
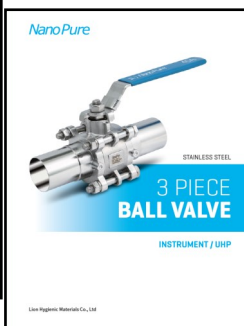

<http://www.advantorr.com/download-2#high-purity>

Standard Components



STANDARD COMPONENTS

CF Flanges & Fittings



- Vacuum Rating: UHV (Ultra High Vacuum)
- Material: 304LSS (Options for 316LSS and 316LNSS)
- Flange Sizes: 1.33"CF to 16.5"CF
- Tube Sizes: ½" to 14.0"
- Vacuum Range: 760 Torr ~ 1×10^{-10} Torr
- Gasket Material: OFHC Copper
- Temperature Range: -190degC ~ 450degC

ISO & NW Flanges & Fittings



- Vacuum Rating: HV (High Vacuum)
- Material: 304LSS (Options for 316LSS and Aluminum)
- Flange Sizes: ISO63 to ISO630
- Tube Sizes: 2.5" to 26.0"
- Vacuum Range: 760 Torr ~ 1×10^{-8} Torr
- Gasket Material: FKM, FFKM
- Temperature Range: ≤ 200 degC (150degC sustained)

Butt Weld Fittings



- Weldable fittings including
 - Tubing
 - 45deg and 90deg Elbows
 - Conical Reducers
 - Equal Tees and Reducing Tees
 - 4-way, 5-way and 6-way Crosses
- Suitable for welding to any flange or fitting with same tube size
- Tube Sizes: ½" to 6.0" OD
- Material: 304LSS

STANDARD COMPONENTS

KF/DN Flanges & Fittings



- Vacuum Rating: HV (High Vacuum)
 - Material: 304LSS (Options for 316LSS and Aluminum)
 - Flange Sizes: KF10 to KF50
 - Tube Sizes: ½" to 2.0"
 - Vacuum Range: 760 Torr ~ 1x10⁻⁸ Torr
 - Gasket Material: FKM, FFKM
 - Temperature Range: ≤200degC
-

Adaptors



- Vacuum Rating: HV (High Vacuum)
 - Material: 304LSS (Options for 316LSS and Aluminum)
 - Adapts from one flange style to another flange or fitting style
 - Adapter Options: CF, KF, ISO, Quick Coupling, VCR, Two-Ferrule, NPT
-

Bellows & Flexible Hoses



- Metal Bellows and Metal Hose
 - Accommodates flange misalignments
 - Provides vibration dampening
- Bellows and Hose Sizes: 0.75" to 6.0"
- Flange Styles: CF, KF, ISOK
- Material: 304LSS

Chambers



GNB CHAMBERS

Our chambers are produced in our 70,000 sq.ft. facility in Elk Grove, CA
Free consulting on Chambers

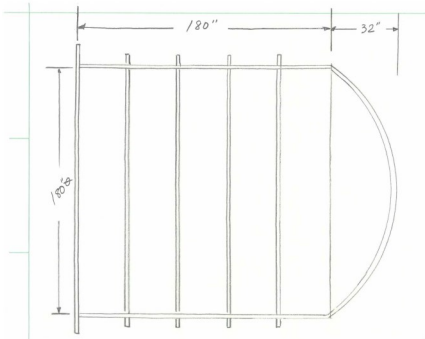

GNB chamber design process

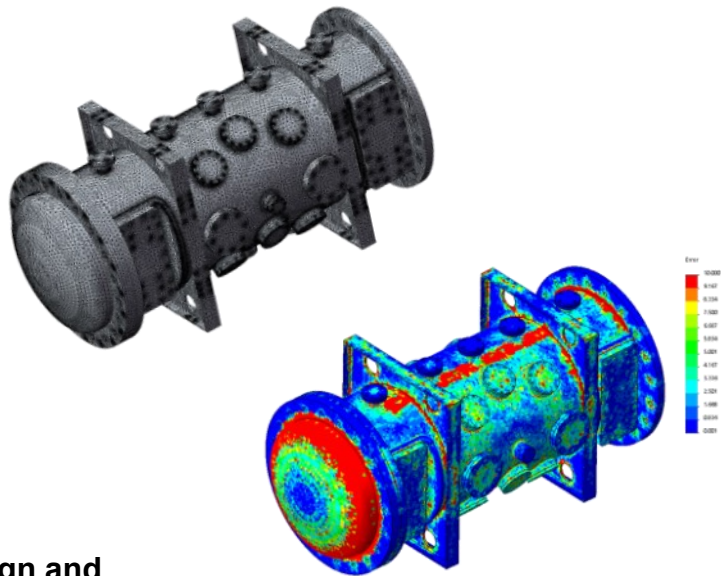
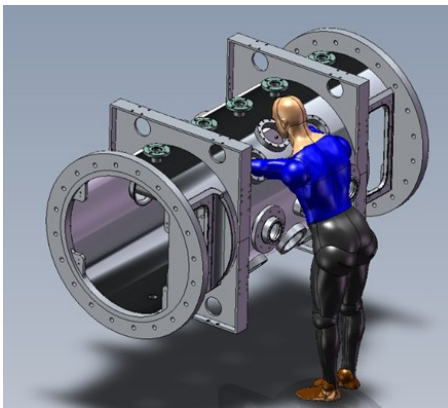

GNB has an ASME U-Stamp to design and produce pressure vessels

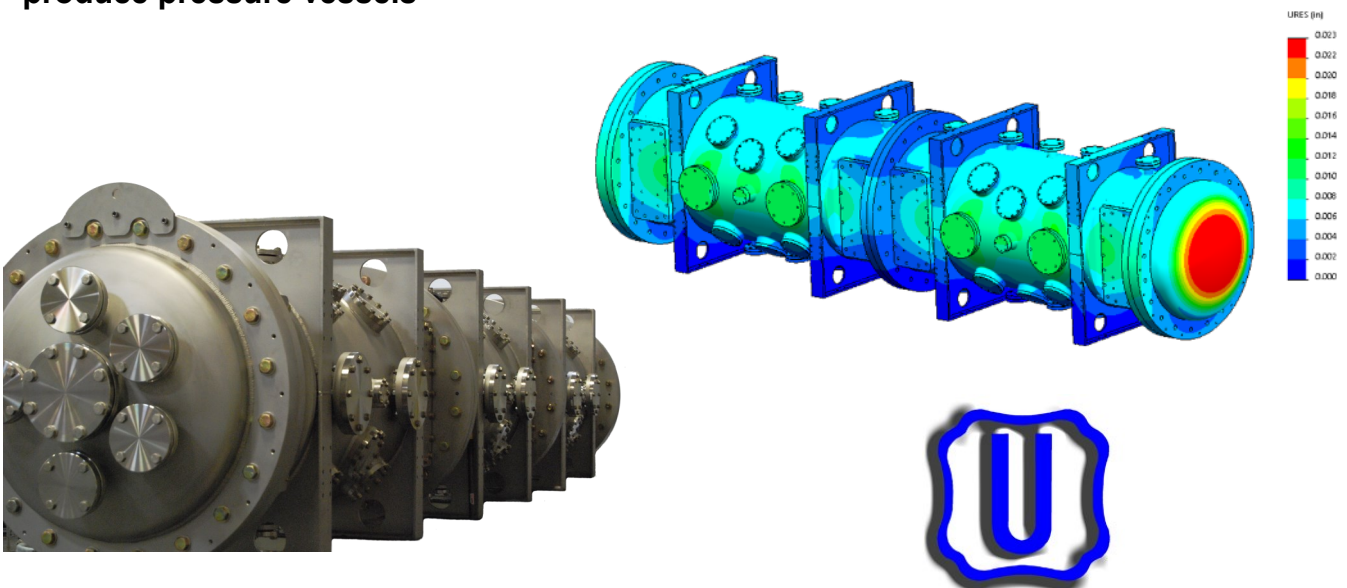

GNB CHAMBERS

Cutting

- Waterjet 12ft. X 8ft. (3657mm x 2438mm)
- Saw: 13' (330mm)

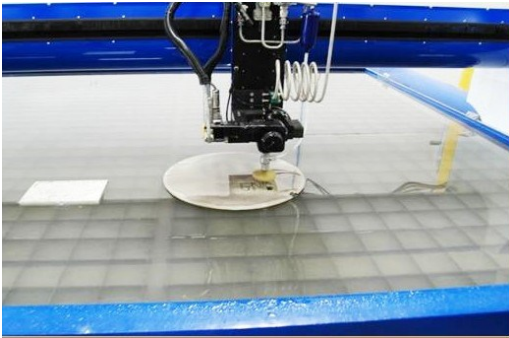

Welding

- TIG and MIG welding of Aluminum and Steel
- Lifting capacity 30tons
- ASME Certified Welders
- 2 CWI's on Site



GNB CHAMBERS

Machining

- CNC milling up to 168" sq
- Turning up to 108"
- High Speed Machining of Aluminum



Variety of Machines



Surface Treatment

- In house graining and blasting (15ft x 12ft x 12ft)
- Painting
- Various cleaning processes available



GNB CHAMBERS

Assembly, Leak Test and RGA

- All chambers will get helium leak tested prior to shipment
- GNB can perform RGA scans at room temperature and elevated temperatures
- GNB can perform bake outs

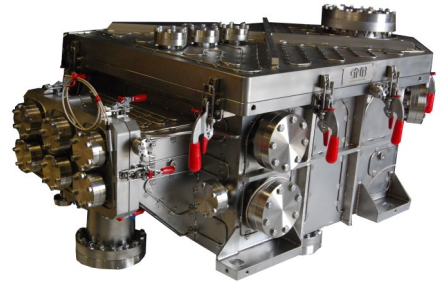

Shipping

- GNB can arrange worldwide shipping



GNB CHAMBERS



GNB CHAMBERS





GNB Corporation

3200 Dwight Rd, Suite. 100
Elk Grove, CA USA 95758

Phone: (916) 395-3003

Fax: (916) 395-3363

Email: info@gnbvac.com

Website: www.gnbvac.com

Toll-Free: 1-800-398-8470